

PARTITION WITH A SINGLE SWING FRAMELESS DOOR
WITH A TRANSOM

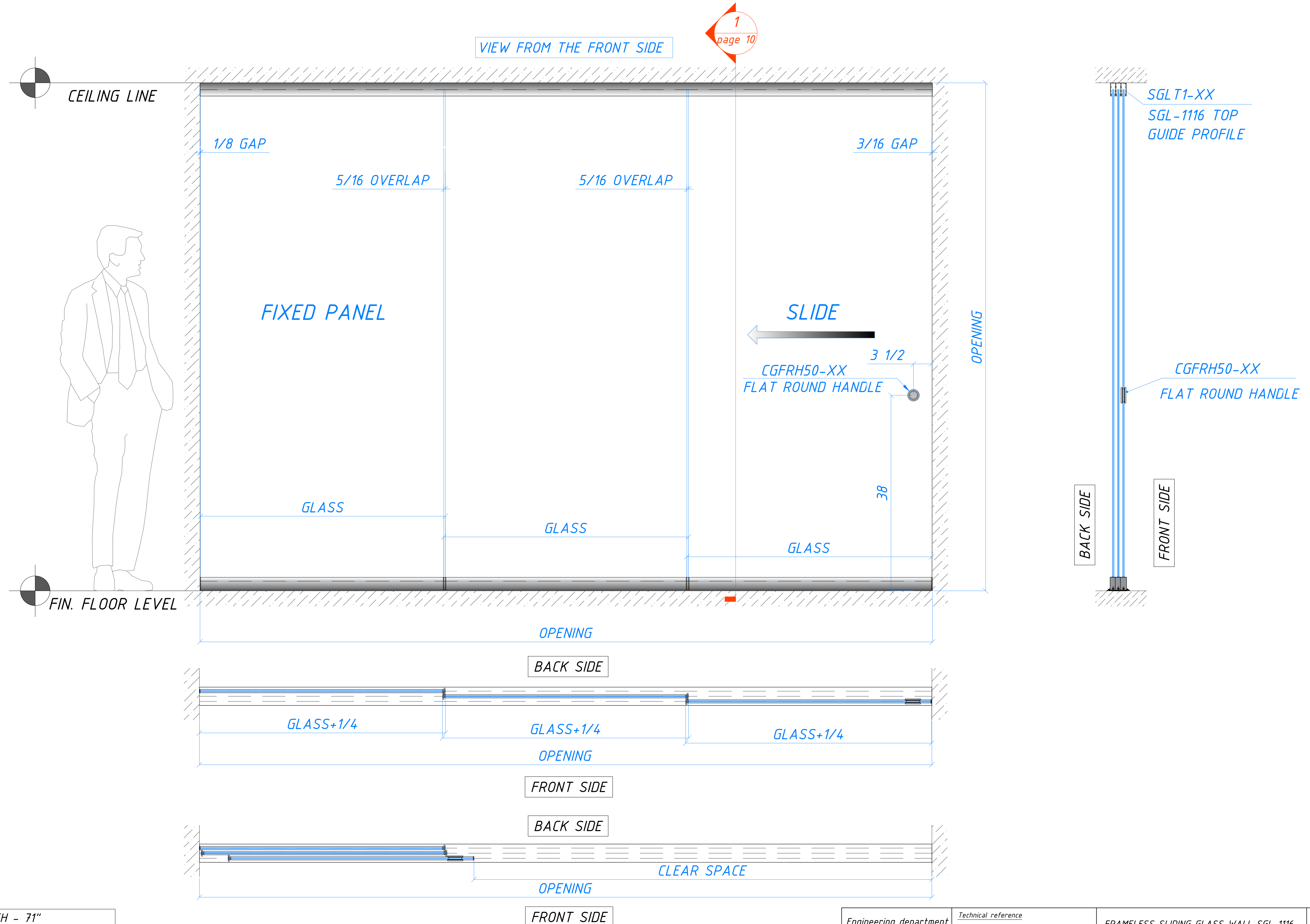

- MAX PANEL WIDTH - 71"
- MAX PANEL HEIGHT - 144"
- MAX PANEL NUMBERS - 12 PC

Engineering department	Technical reference	FRAMELESS SLIDING GLASS WALL SGL-1116	
CRYSTALIA GLASS architectural glass & metal 132 32ND STREET BROOKLYN, NY 11232 (347) 601-20-19 SALES@CRYSTALGLASS.COM	Created by	SINGLE SLIDING TYPE 1	
	Approved by		
	Date of issue	Drawing title	
		1	

VIEW FROM THE FRONT SIDE

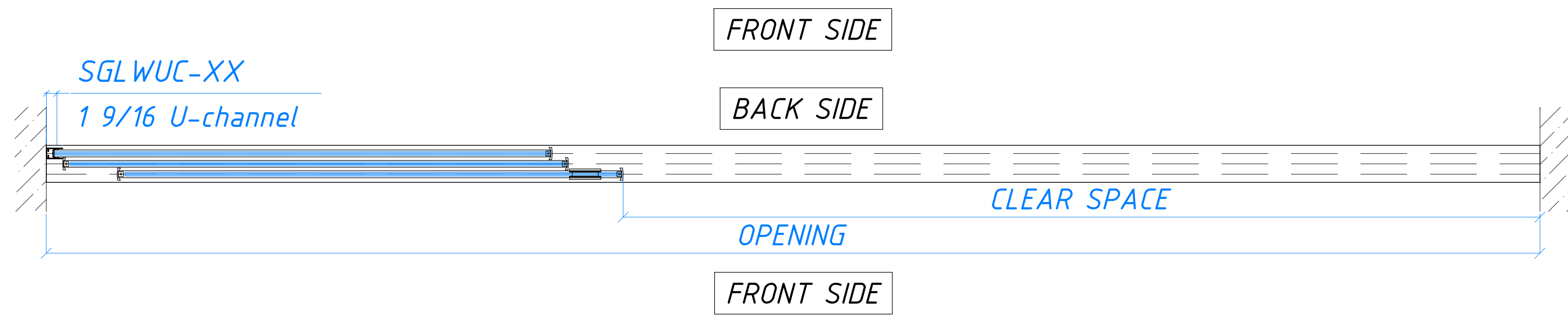
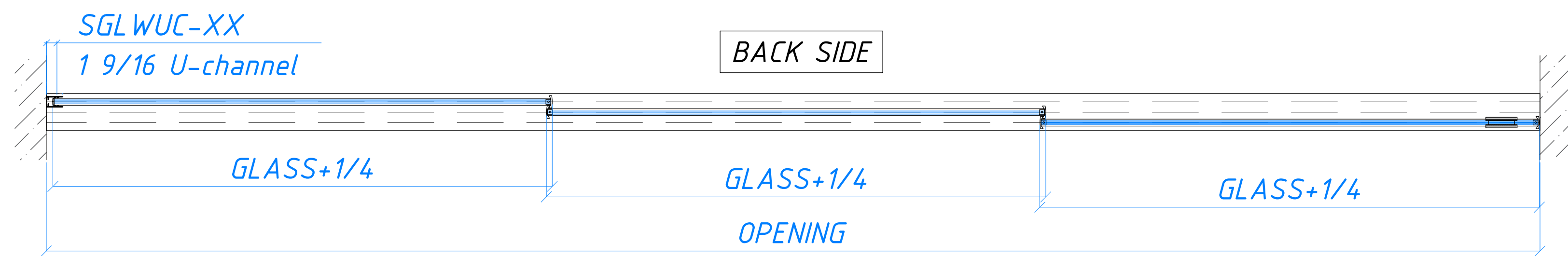
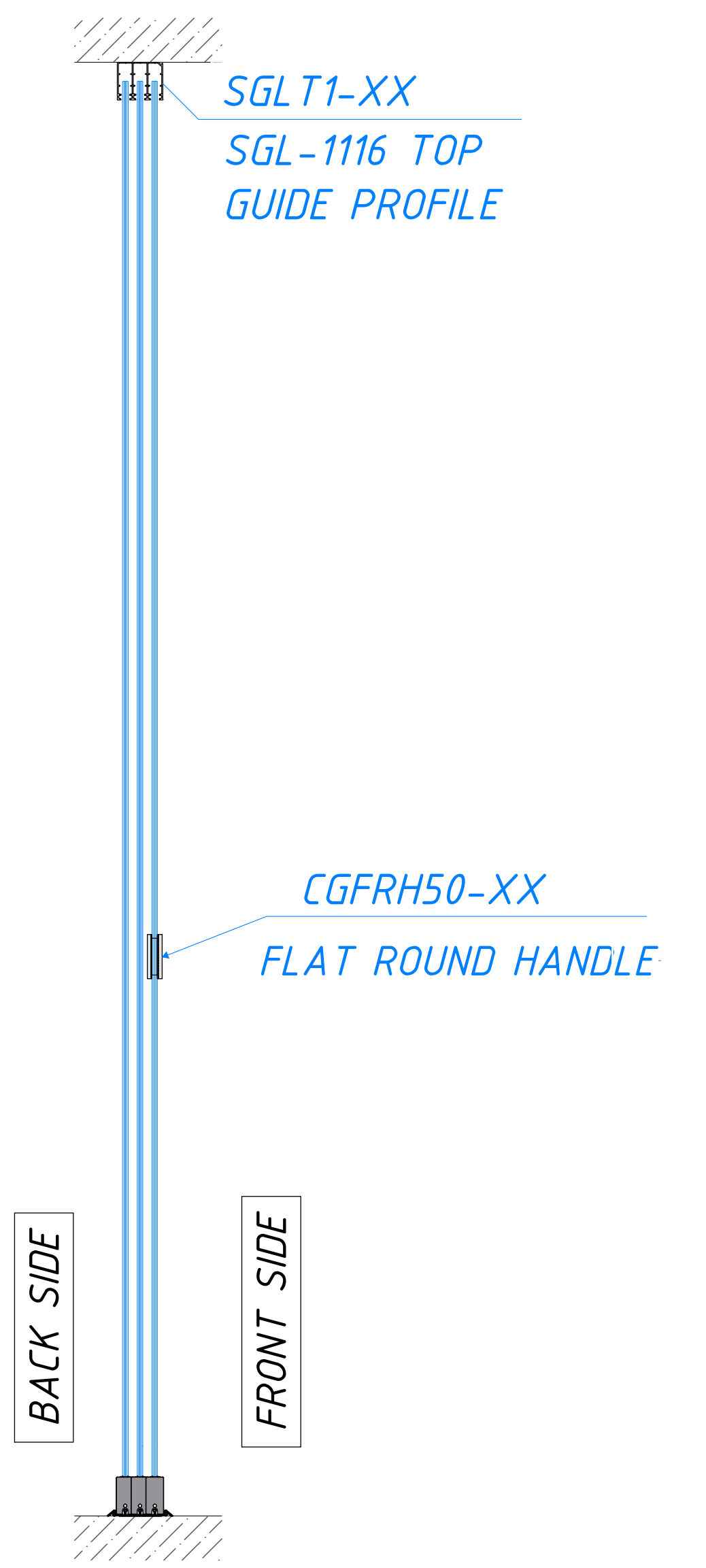
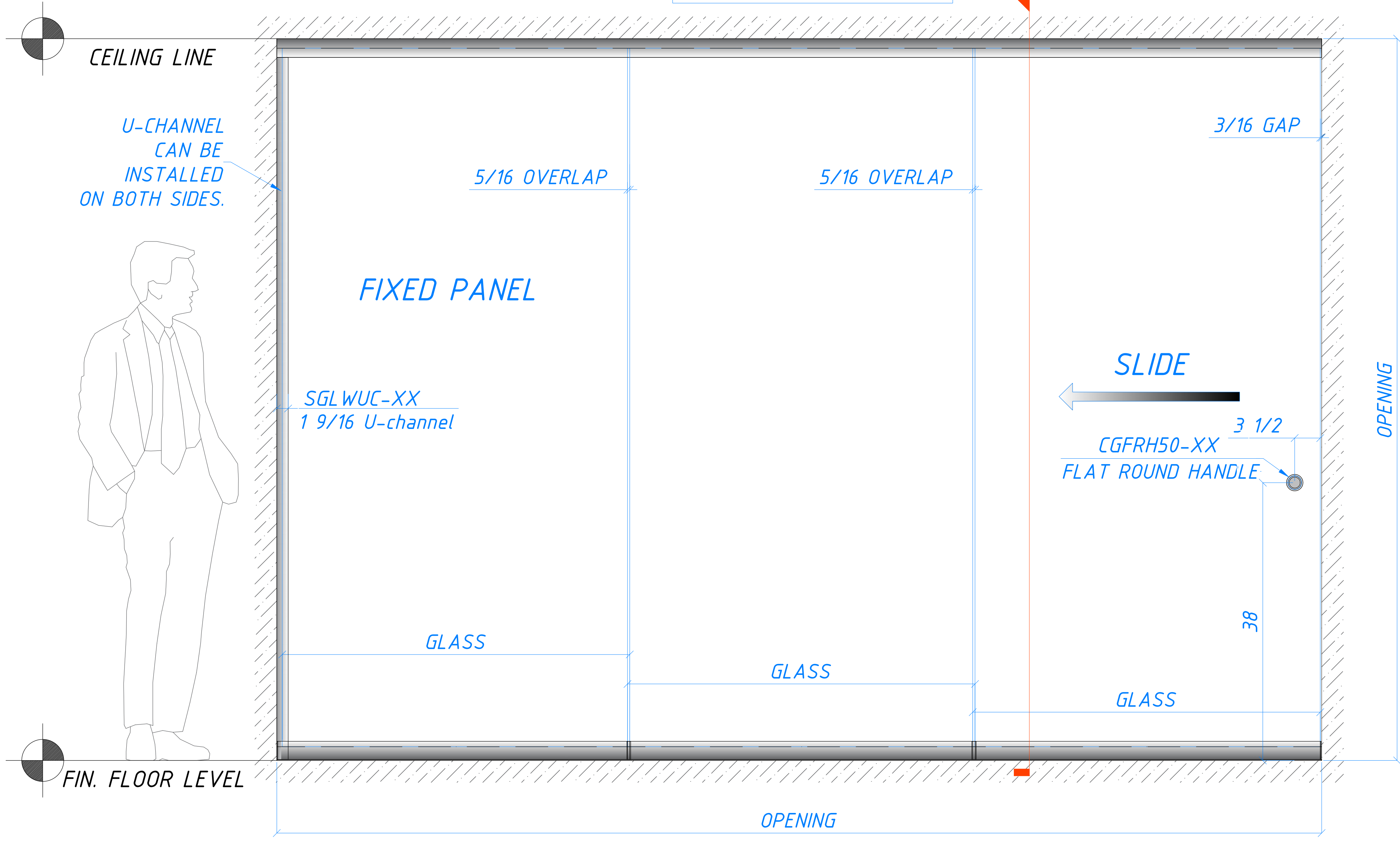

Engineering department	Technical reference	FRAMELESS SLIDING GLASS WALL SGL-1116	
CRYSTALIA GLASS architectural glass & metal 132 32ND STREET BROOKLYN, NY 11232 (347) 601-20-19 SALES@CRYSTALIAGLASS.COM	Created by	SINGLE SLIDING TYPE 2	
	Approved by		
			2

VIEW FROM THE FRONT SIDE

1
page 10

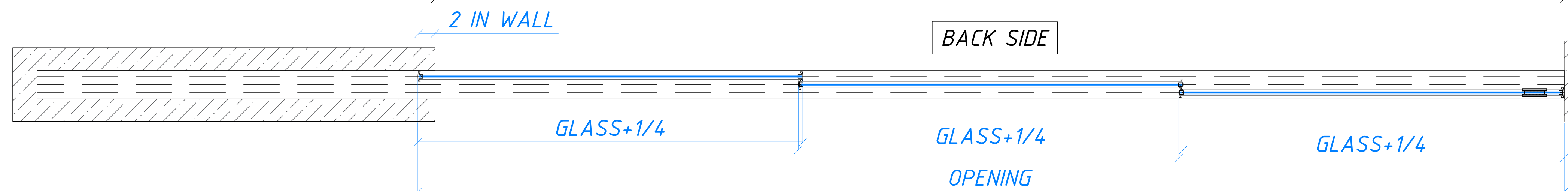
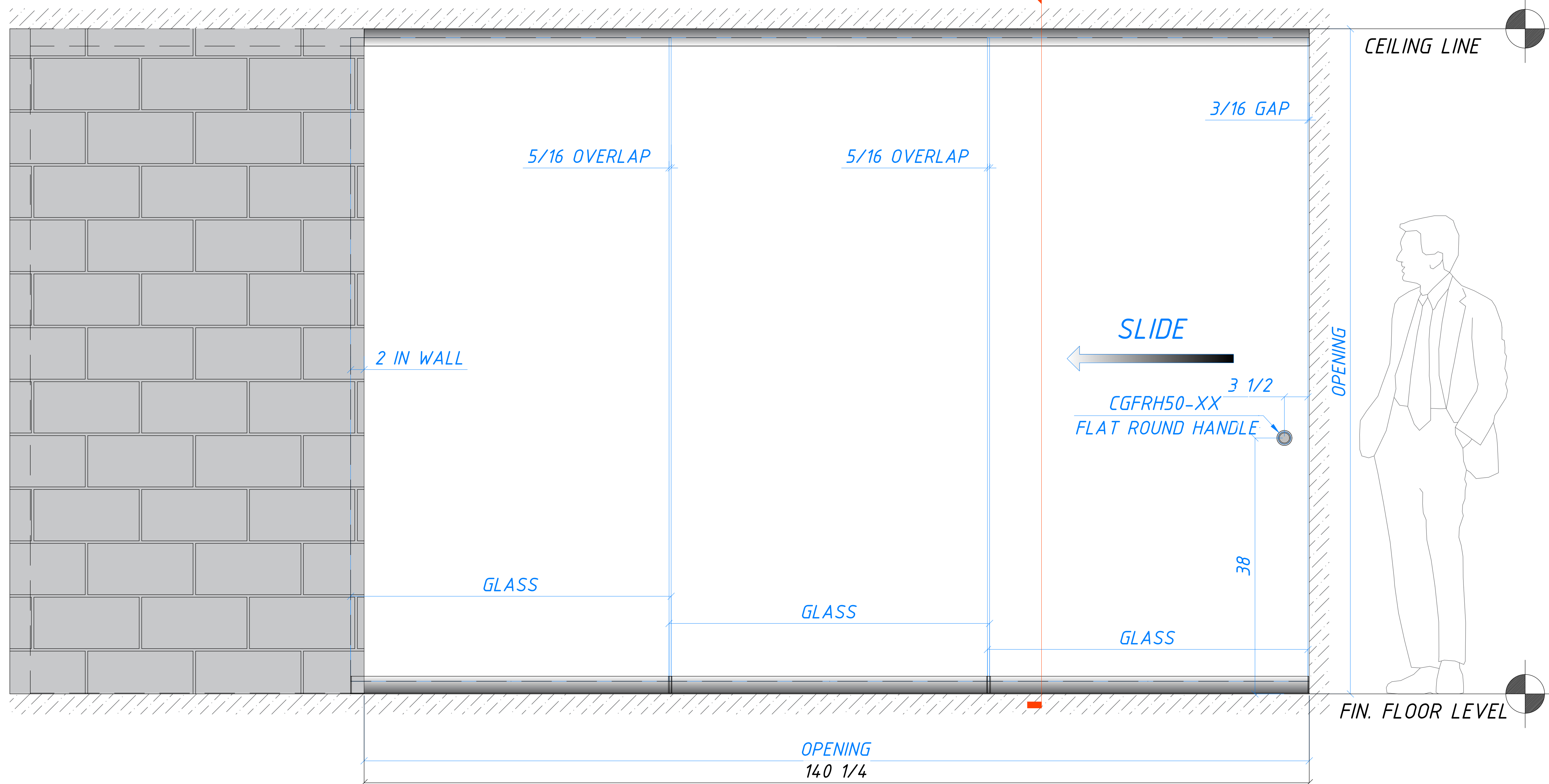

FRONT SIDE

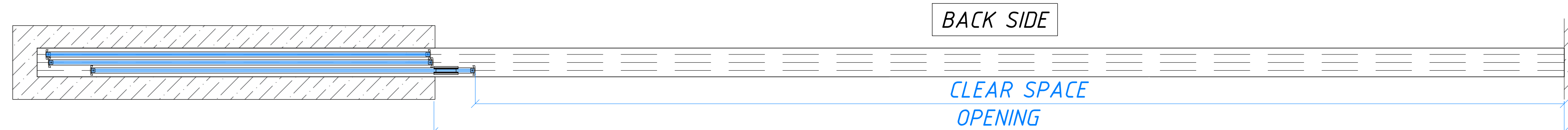

FRONT SIDE

Engineering department	Technical reference	FRAMELESS SLIDING GLASS WALL SGL-1116	
CRYSTALIA GLASS architectural glass & metal 132 32ND STREET BROOKLYN, NY 11232 (347) 601-20-19 SALES@CRYSTALIAGLASS.COM	Created by	SINGLE SLIDING TYPE 3	Date of issue
	Approved by		
			3

VIEW FROM THE FRONT SIDE

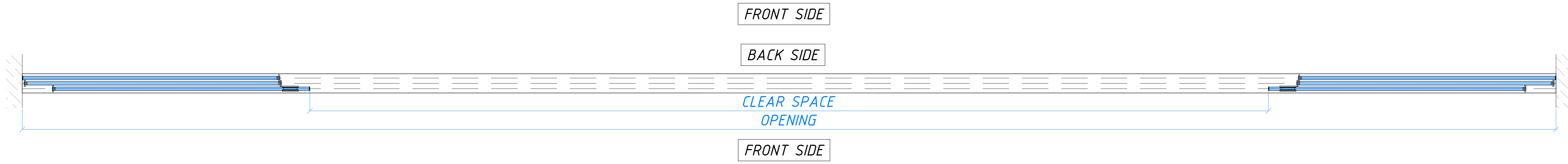
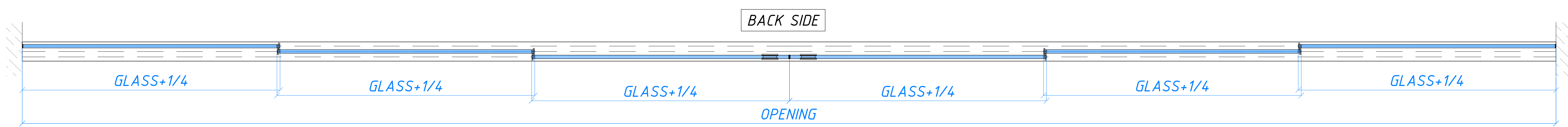
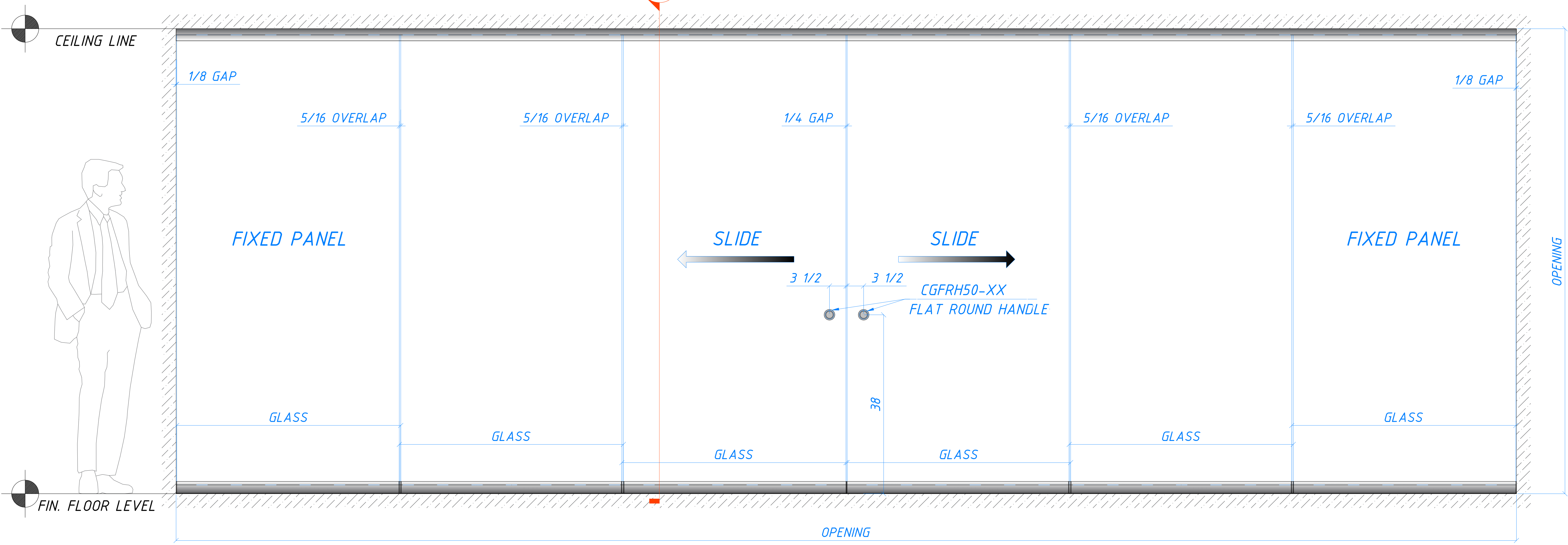

Engineering department	Technical reference	FRAMELESS SLIDING GLASS WALL SGL-1116	
CRYSTALIA GLASS architectural glass & metal 132 32ND STREET BROOKLYN, NY 11232 (347) 601-20-19 SALES@CRYSTALIAGLASS.COM	Created by	DOUBLE SLIDING TYPE 1	
	Approved by		
	Date of issue	Drawing title	
		4	

VIEW FROM THE FRONT SIDE

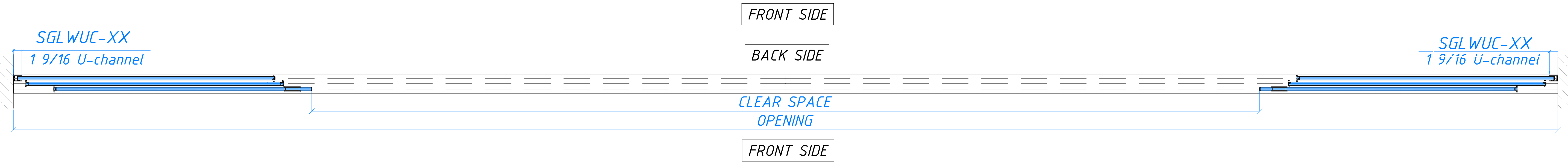
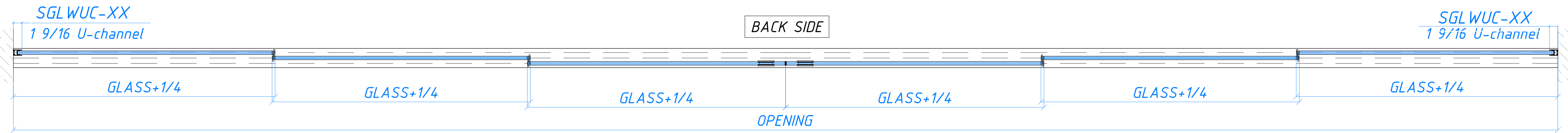
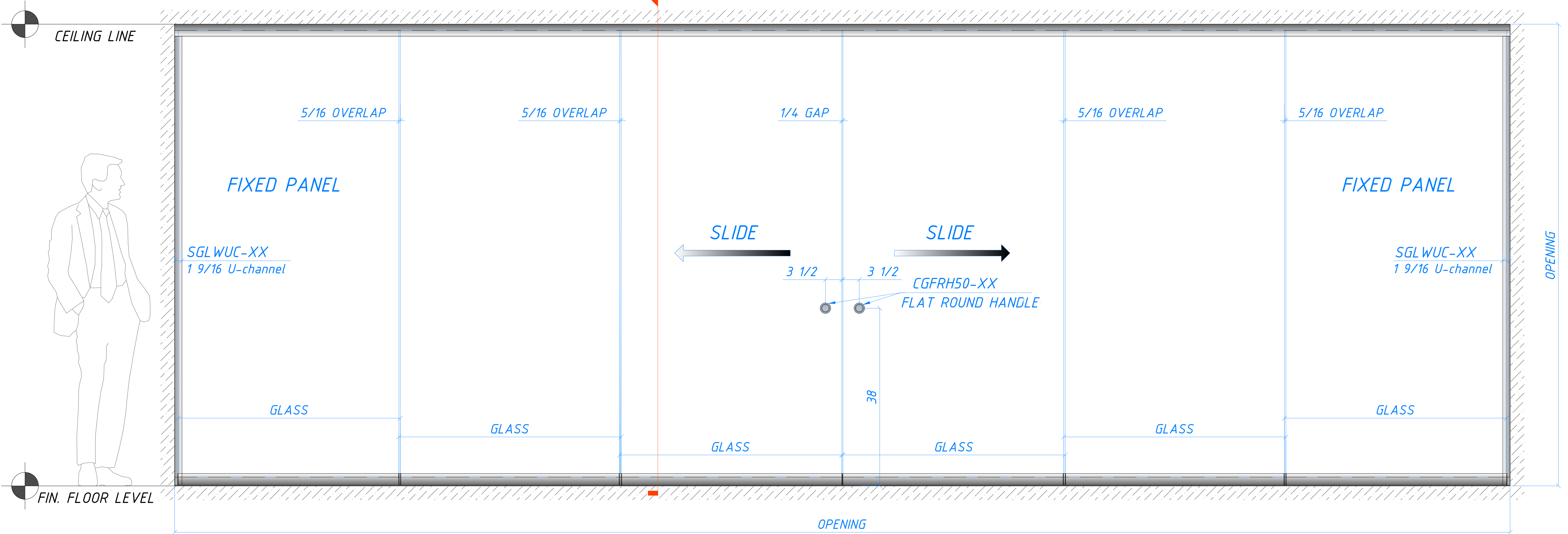

Engineering department	Technical reference	FRAMELESS SLIDING GLASS WALL SGL-1116	
CRYSTALIA GLASS architectural glass & metal 132 32ND STREET BROOKLYN, NY 11232 (347) 601-20-19 SALES@CRYSTALIAGLASS.COM	Created by	DOUBLE SLIDING TYPE 2	Date of issue
	Approved by		
			5

1
page 10

VIEW FROM THE FRONT SIDE

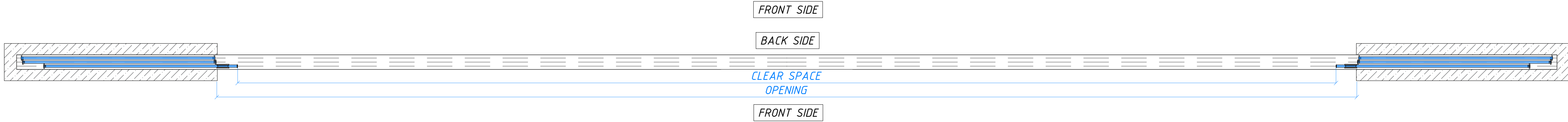
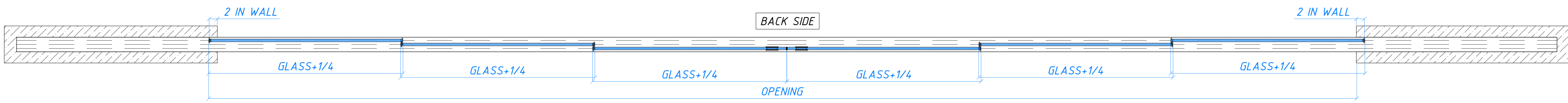
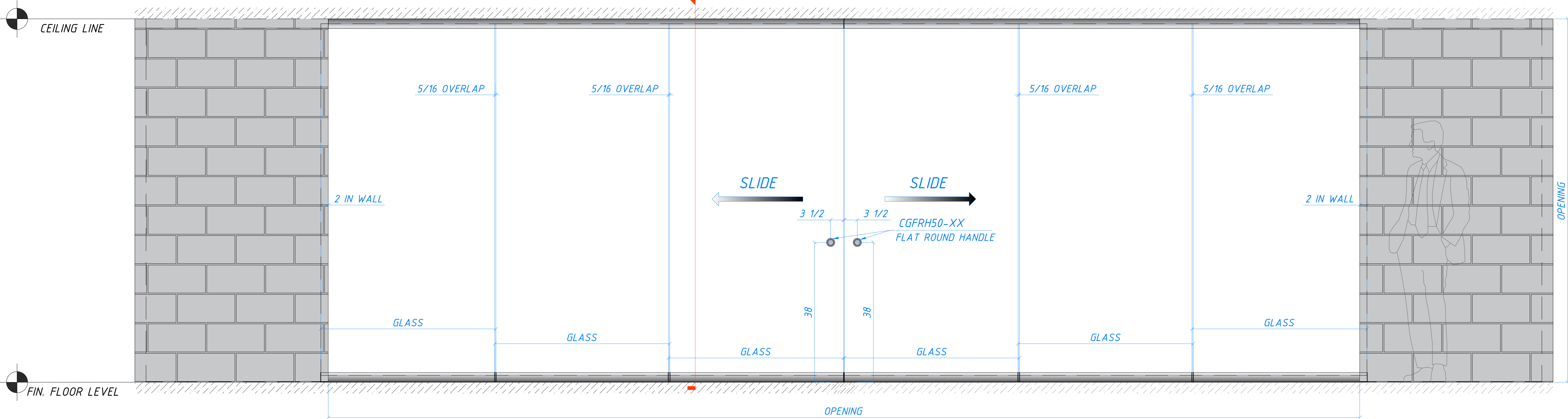

Engineering department	Technical reference	FRAMELESS SLIDING GLASS WALL SGL-1116	
CRYSTALIA GLASS architectural glass & metal 132 32ND STREET BROOKLYN, NY 11232 (347) 601-20-19 SALES@CRYSTALIAGLASS.COM	Created by	DOUBLE SLIDING TYPE 3	Date of issue
	Approved by		Drawing title
			6

VIEW FROM THE TOP

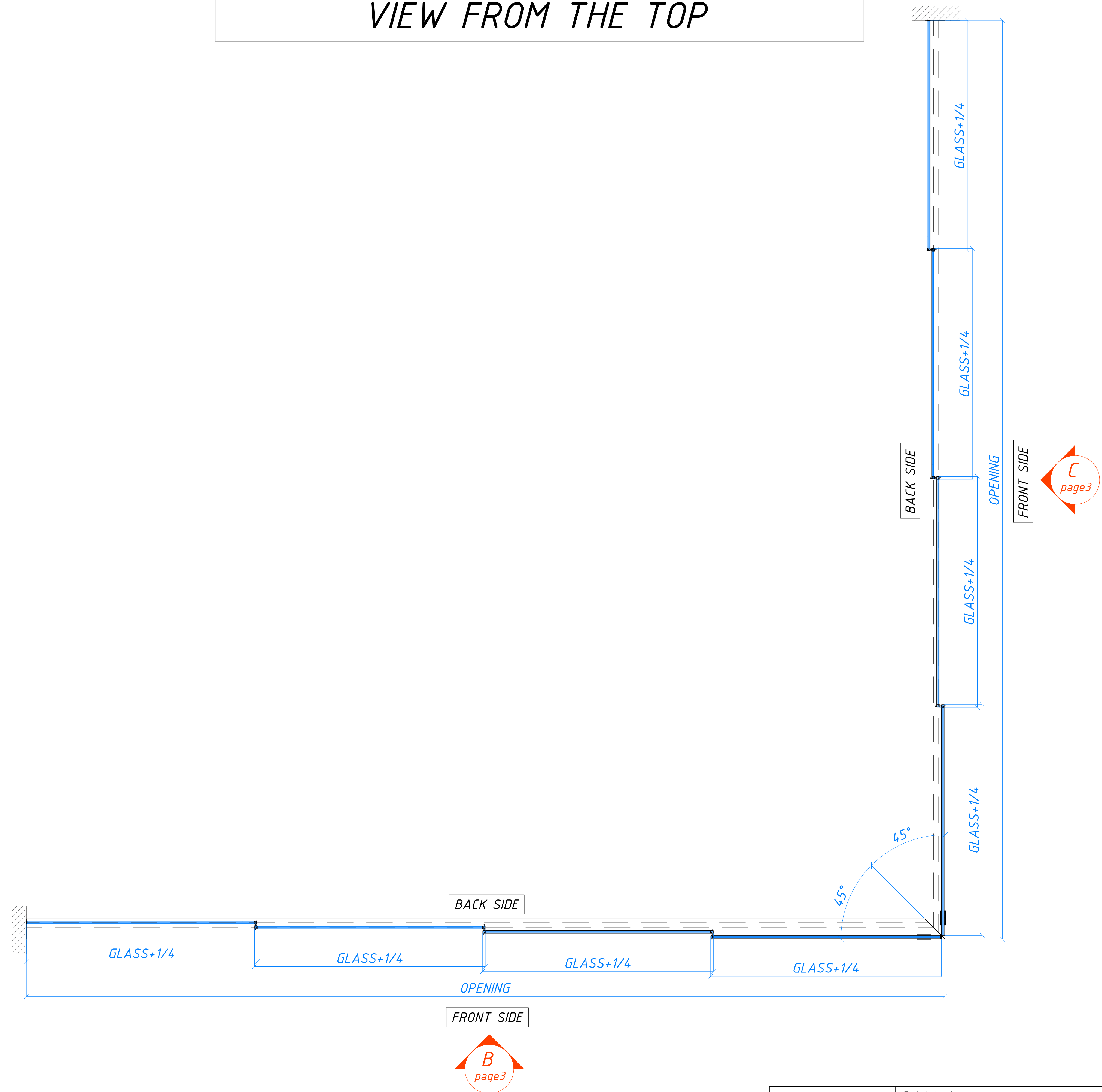

Engineering department	Technical reference	FRAMELESS SLIDING GLASS WALL SGL-1116	
CRYSTALIA GLASS architectural glass & metal 132 32ND STREET BROOKLYN, NY 11232 (347) 601-20-19 SALES@CRYSTALIAGLASS.COM	Created by	DOUBLE SLIDING L-SHAPE 90°	Date of issue
	Approved by		
			7

VIEW "B" FROM THE FRONT SIDE

2
page 11

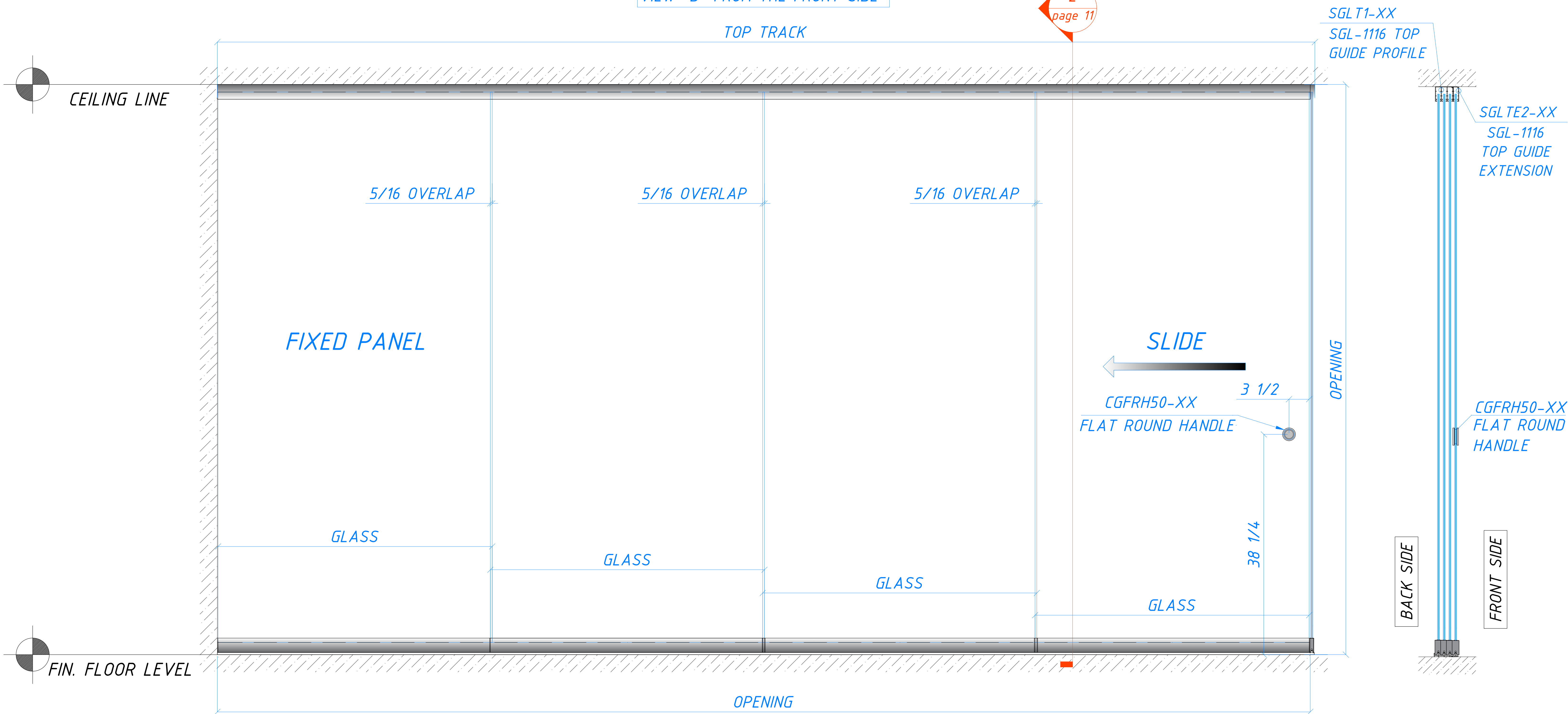

Engineering department	Technical reference	FRAMELESS SLIDING GLASS WALL SGL-1116	
CRYSTALIA GLASS architectural glass & metal 132 32ND STREET BROOKLYN, NY 11232 (347) 601-20-19 SALES@CRYSTALIAGLASS.COM	Created by	DOUBLE SLIDING L-SHAPE 90°	Date of issue
	Approved by		
			8

VIEW "C" FROM THE FRONT SIDE

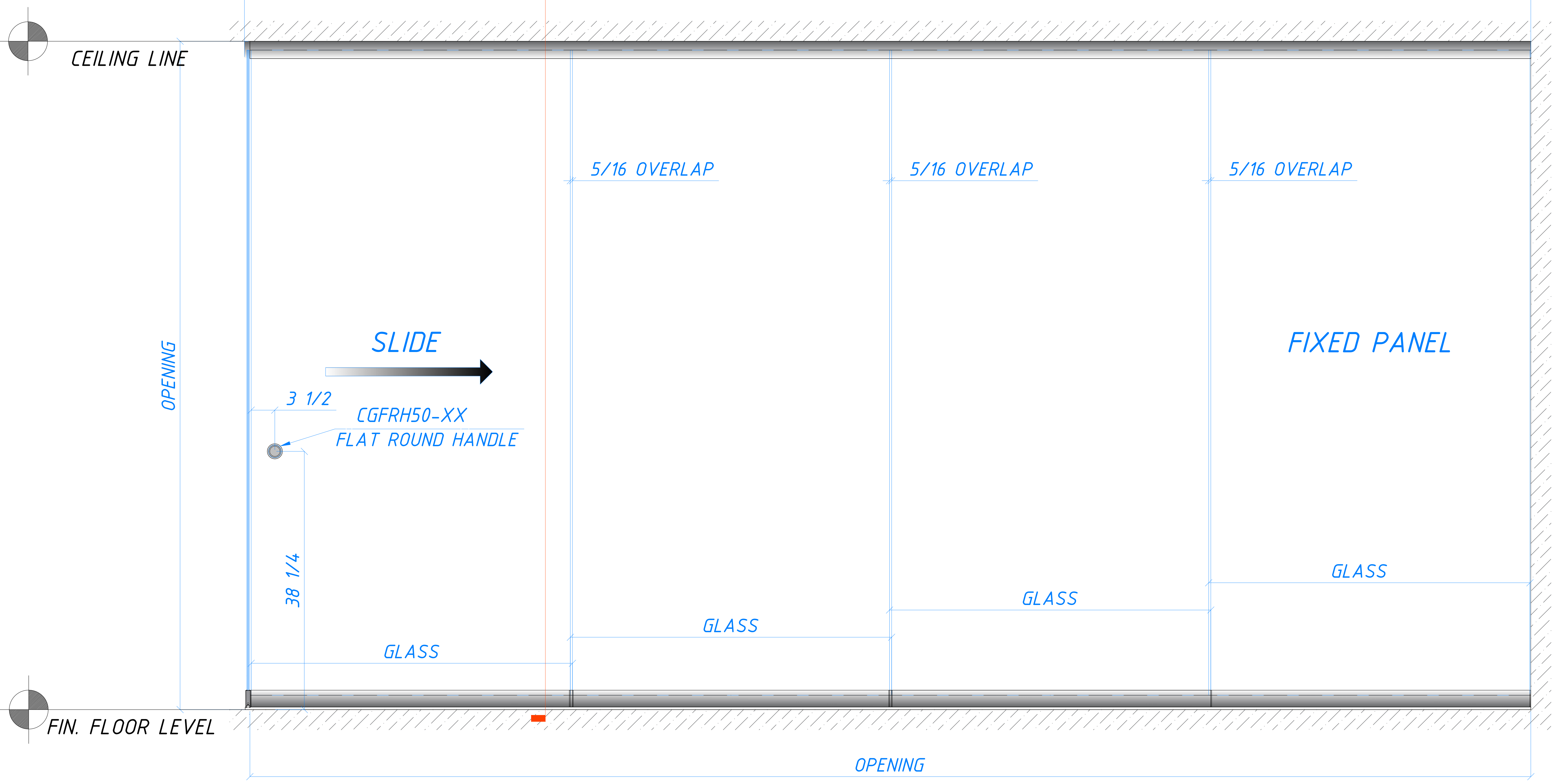

Engineering department	Technical reference	FRAMELESS SLIDING GLASS WALL SGL-1116	
CRYSTALIA GLASS architectural glass & metal 132 32ND STREET BROOKLYN, NY 11232 (347) 601-20-19 SALES@CRYSTALIAGLASS.COM	Created by	DOUBLE SLIDING L-SHAPE 90°	Date of issue
	Approved by		
			9

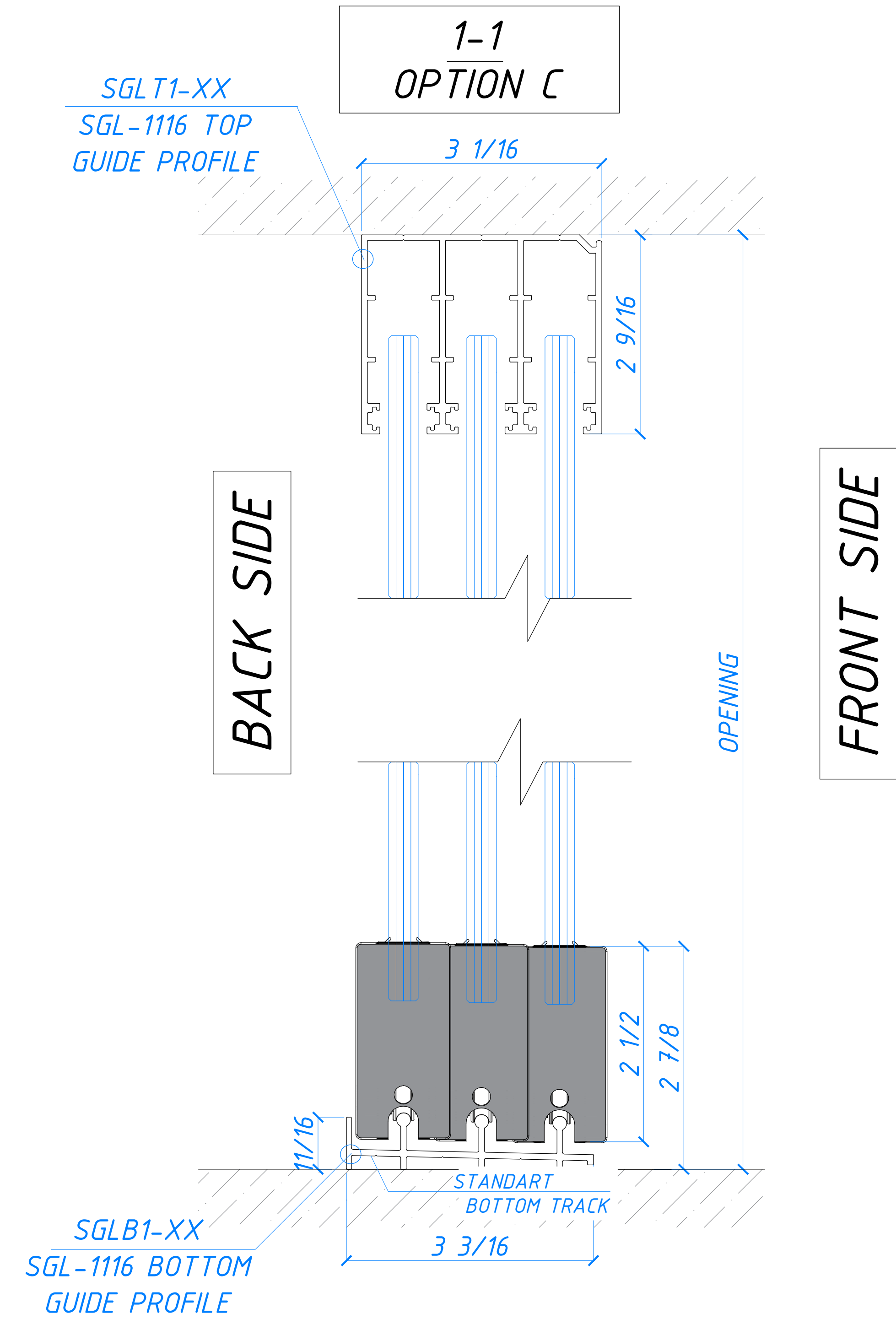
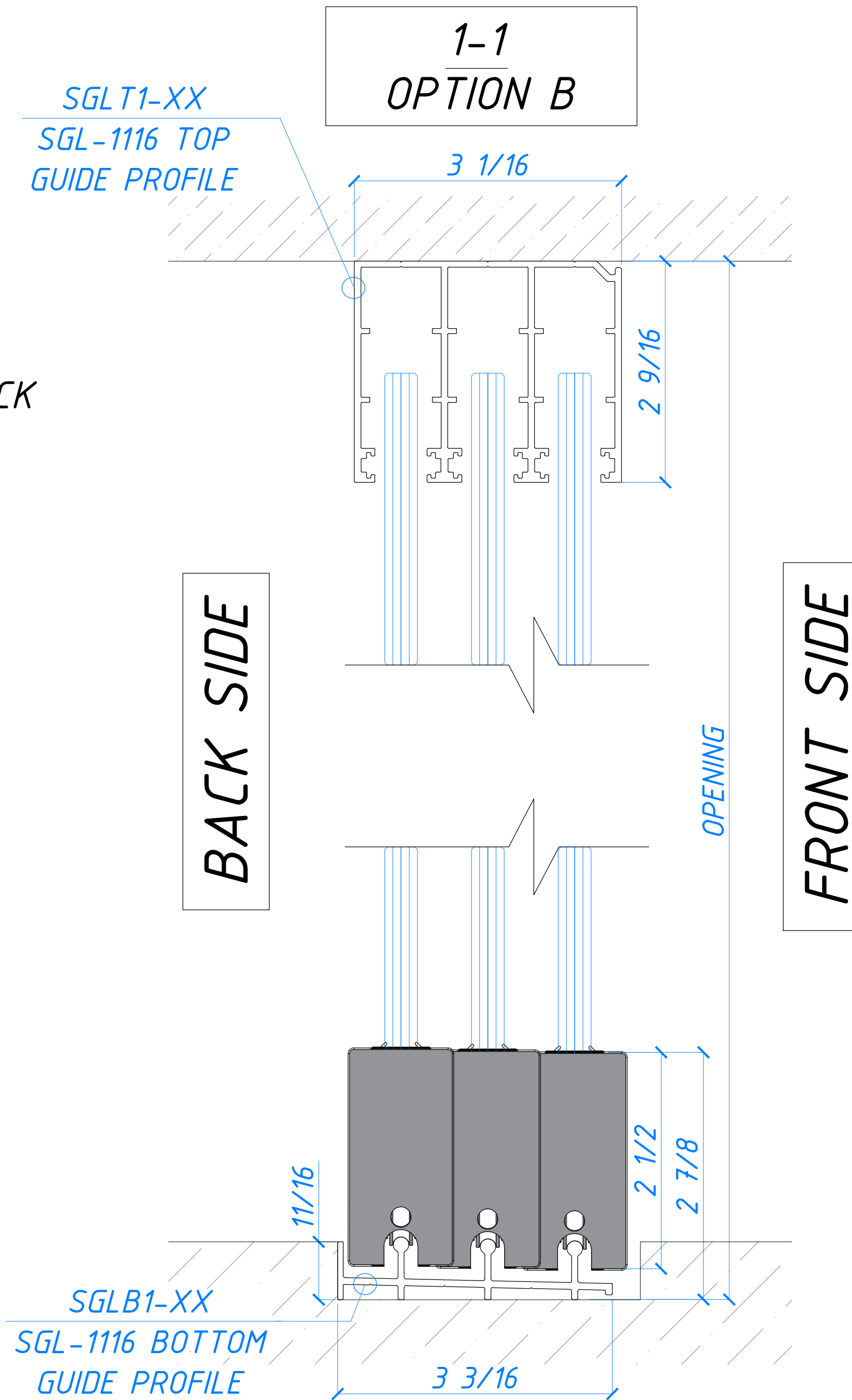
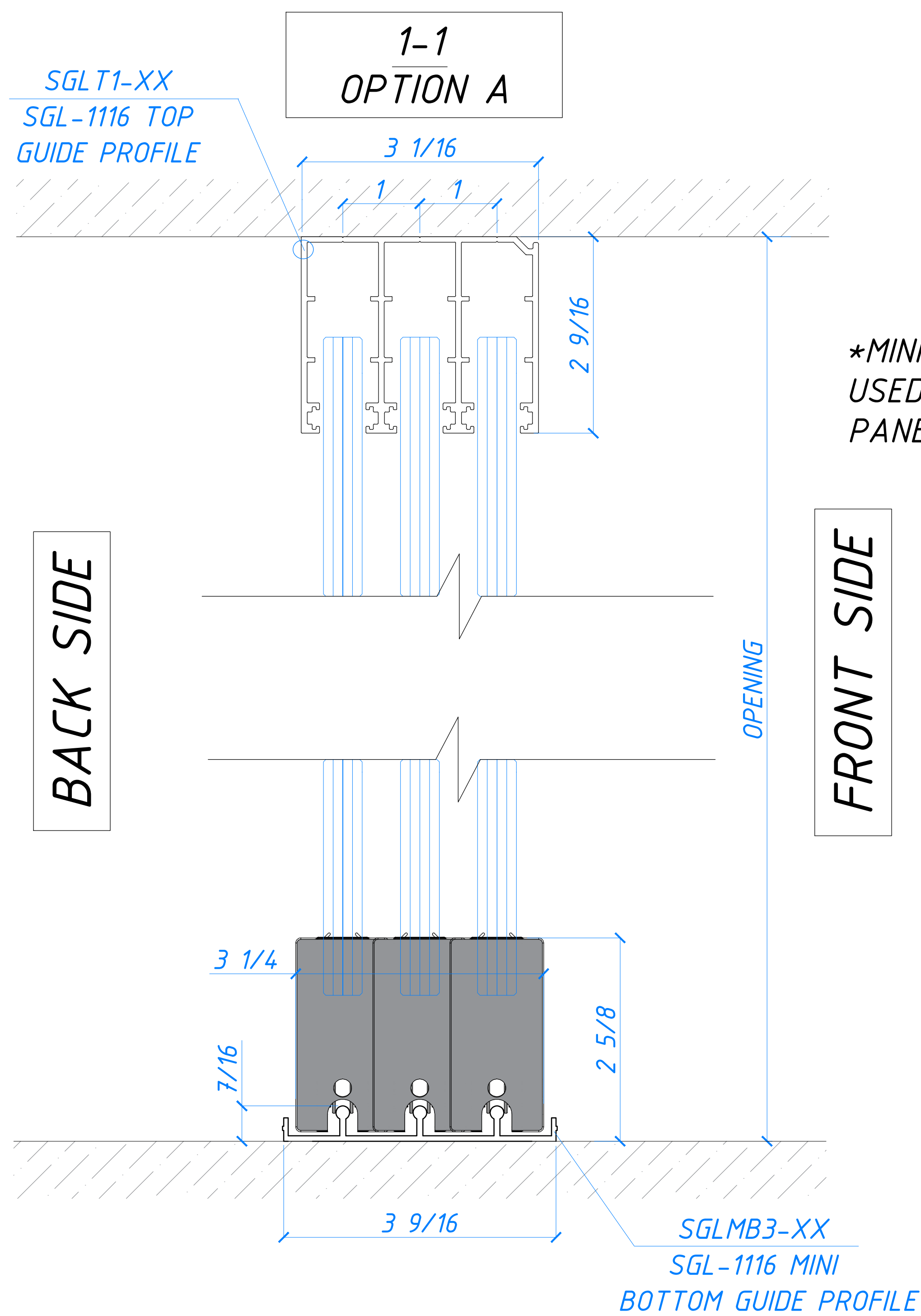

Engineering department	Technical reference	FRAMELESS SLIDING GLASS WALL SGL-1116	
CRYSTALIA GLASS architectural glass & metal 132 32ND STREET BROOKLYN, NY 11232 (347) 601-20-19 SALES@CRYSTALIAGLASS.COM	Created by	SECTION 1	
	Approved by		
	Date of issue	Drawing title	
		10	

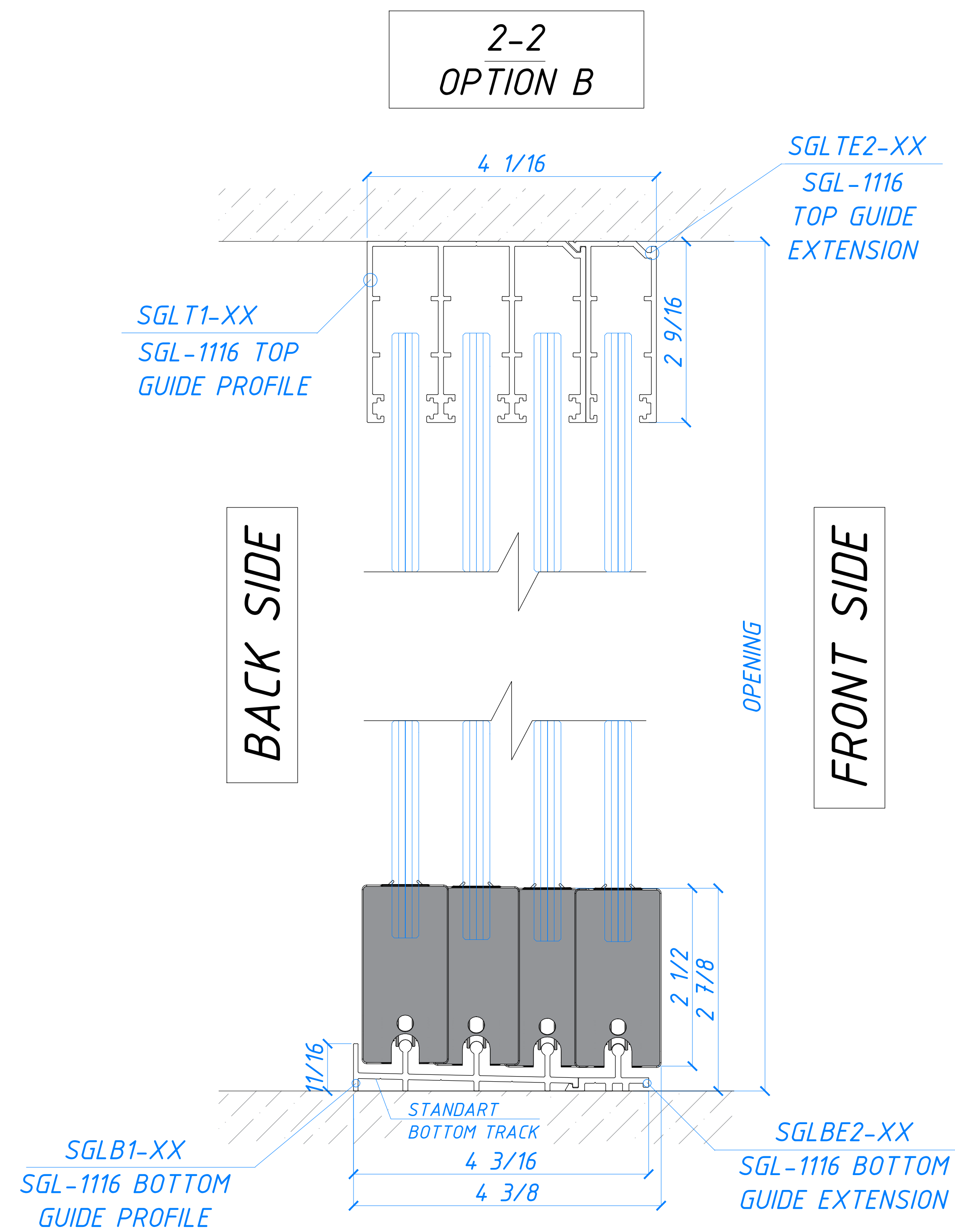
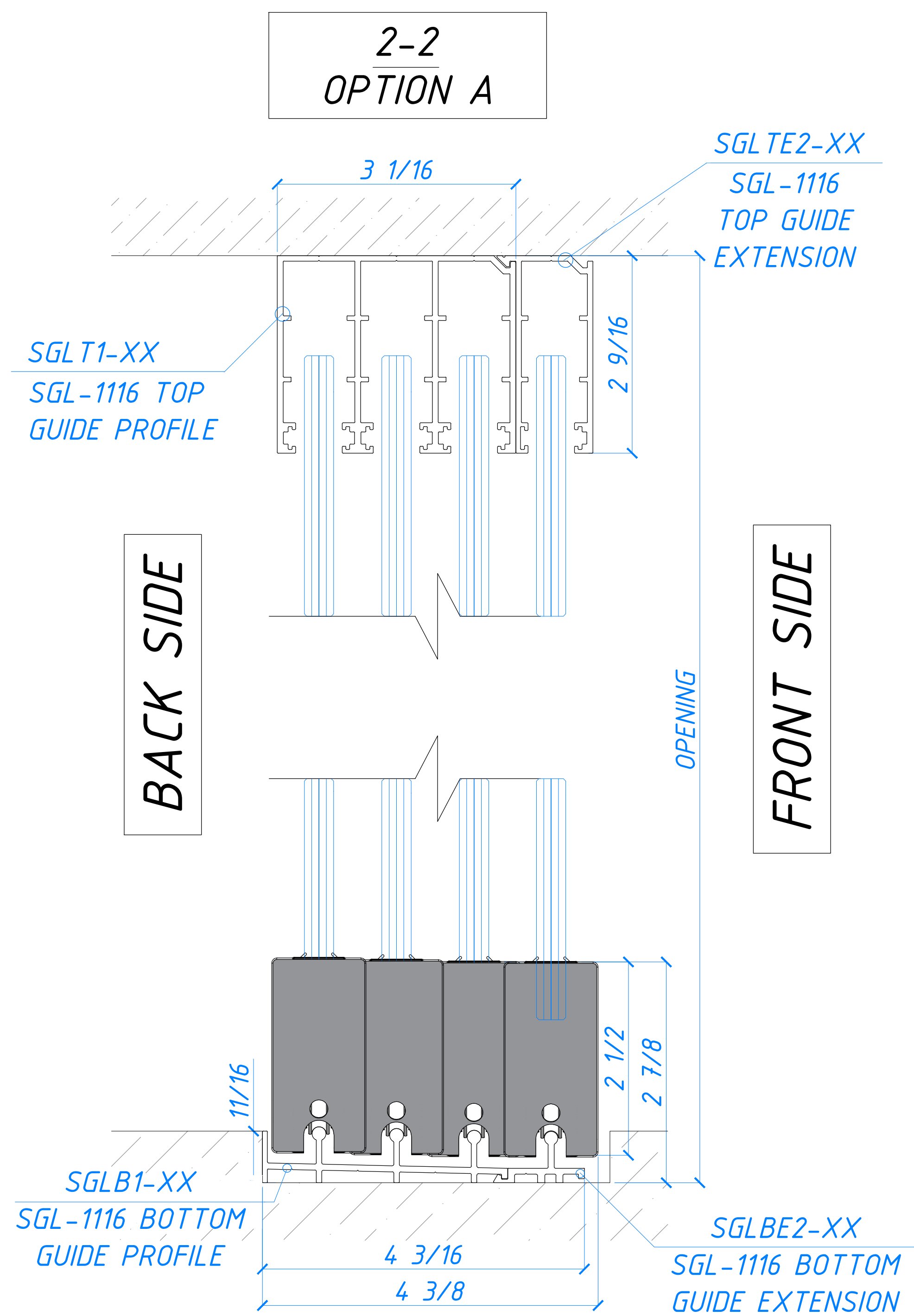

Engineering department	Technical reference	FRAMELESS SLIDING GLASS WALL SGL-1116	
CRYSTALIA GLASS architectural glass & metal 132 32ND STREET BROOKLYN, NY 11232 (347) 601-20-19 SALES@CRYSTALIAGLASS.COM	Created by	SECTION 2	Date of issue
	Approved by		
			11